



فرست اوتوماشن

LED Marking Light

Series CZ0264



Prodcuts Features

- Explosion-proof LED marking light.
- Explosion-proof LED emergency marking light, emergency time 160min.
- Emergency type has indicator for fault, charging and discharge.
- Emergency types have maintained and non-maintained type. Maintained type can work when either normal power on or emergency power on. Non-maintained type can only work when emergency power on.
- 16 labels for options, others are also available on request.
- IECEx and ATEX certified.





فرست اوتوماشن

LED Marking Light

Series CZ0264



Product Parameter

Certification:	CCC IECEX ATEX
Application range (zones):	2G/Gb/zone 1; 2D/Db/zone 21
Min.ambient temperature:	-20°C
Max.ambient temperature:	+55°C
Degree of protection:	IP66
Rated voltage:	AC100 ~ 250V 50/60Hz
Rated power:	3W
Weight:	3.20kg



فرست اوتوماشن

LED Marking Light

Series CZ0264



Illustration	Order No.
	CZ0264/20-LED3W-□-B
	CZ0264/20-LED3W-□-KF-B
	CZ0264/20-LED3W-M-□-B
	CZ0264/20-LED3W-NM-□-B
	CZ0264/20-LED3W-M-□-KF-B
	CZ0264/20-LED3W-NM-□-KF-B



Code: 80



Code: 84



Code: 88



Code: 92



Code: 81



Code: 85



Code: 89



Code: 93



Code: 82



Code: 86



Code: 90



Code: 94



Code: 83



Code: 87



Code: 91



Code: 95



فرست اوتوماشن

LED Marking Light

Series CZ0264

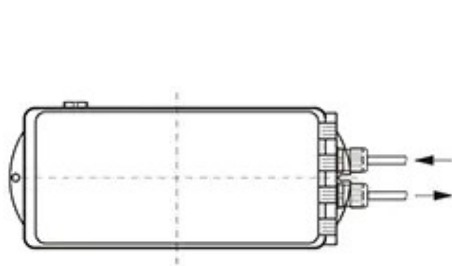
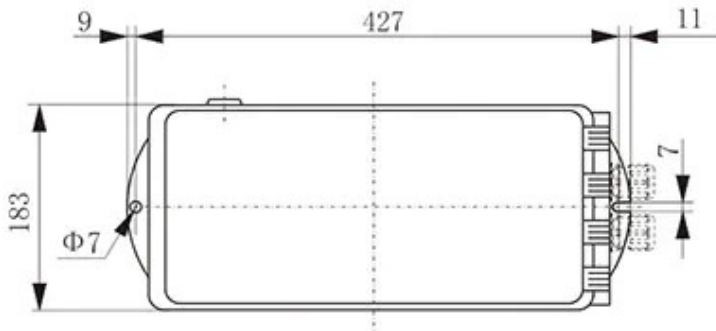
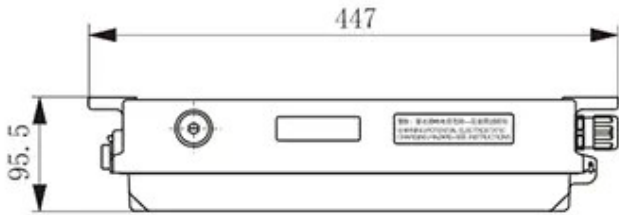

Solution 1

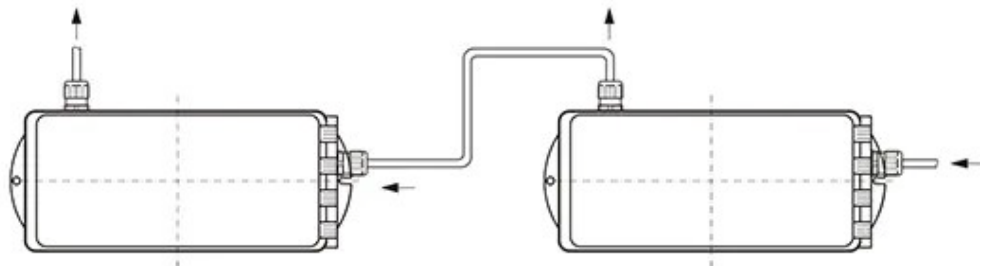

Solution 2



فرست اوتوماشن

LED Marking Light

Series CZ0264



Optional Ex components



| CZ0220 Series Plastic stopping plugs, the reducer



| CZ0221 Metal cable glands



| CZ0220 Series Plastic cable glands, stopping plugs



| CZ0226 Increased safety cable glands



| CZ0527, CZ1725/27 Increased safety breathing, drainage valve



| CZ0227 Increased safety metal cable glands



| CZ1725/1C Metal cable glands



| CZ1725/2A Metal cable glands



| CZ1725/3A Metal stopping plug



| CZ1725/1A Metal cable glands



| CZ1725/4A The reducer



| CZ1725/1B Metal cable glands



فرست اوتوماشن

LED Marking Light

Series CZ0264



Accessories



Explosion-proof Isolation
switch module
Order No.: CZ0207-1

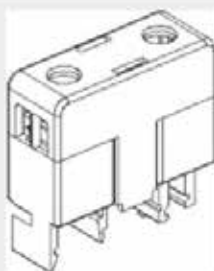

Explosion-proof fuse module
Order No.: CZ0804 / T0.8A
CZ0804 / T1.25A
CZ0804 / T6.3A

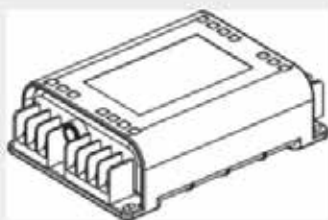

Explosion-proof emergency
battery module
Order No.: CZ0818/58-3W-M
CZ0818/58-3W-NM

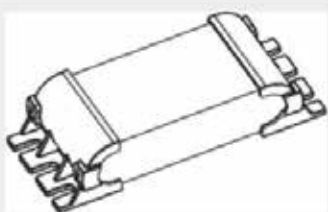

Explosion-proof battery
module
Order No.: CZ0819/1.0Ah/6V



Earthing nut
Order No.: D8714/2-M25

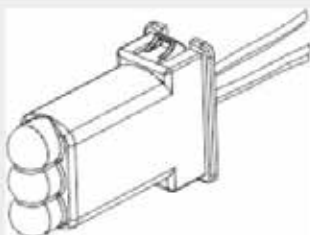

Explosion-proof emergency
indicator module
Order No.: CZ0802/1



M8/SW13 Sleeve spanner
Order No.: D601