



فرست اوتوماشن

# Push Buttons

Series CZ0202



## Prodcuts Features

- Explosion-proof signal lamps for panel mounting have high brightness, long life. The electric life is more than 100,000 hours.
- Degree of protection IP66.
- IECEx International Certification, ATEX European Approval.

## Product Parameter

<b>Product type:</b>	CZ0202 Explosion-proof signal lamp for panel mounting
<b>Certification:</b>	CCC IECEX ATEX
<b>Application range (zones):</b>	2G/Gb/zone 1; 2D/Db/zone 21
<b>Min.ambient temperature:</b>	-40°C
<b>Max.ambient temperature:</b>	+50°C
<b>Degree of protection:</b>	IP66( Match operation head )
<b>Terminals:</b>	2×2.5mm <sup>2</sup>
<b>Rated voltage:</b>	12V - 28V AC/DC 20V - 250V AC/DC 380V - 400V AC
<b>Light source:</b>	LED
<b>Power consumption:</b>	P <sub>max</sub> ≤1W
<b>Electric life:</b>	1, 000,00 hours
<b>Cable entry outer diameter:</b>	φ5.5 ~ 13mm





فرست اوتوماشن

# Push Buttons

Series CZ0202

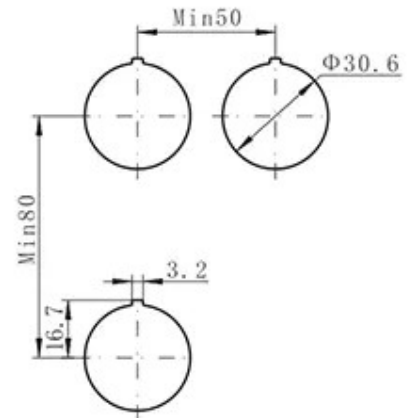
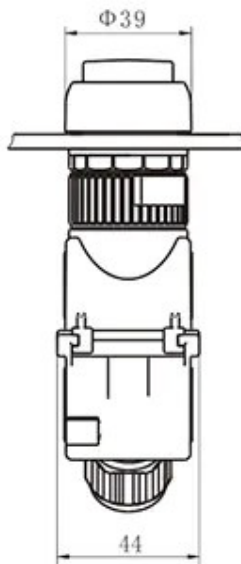
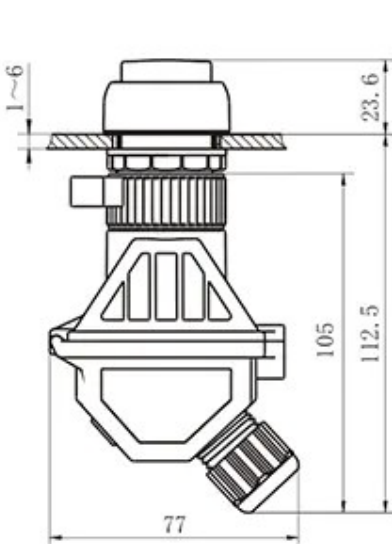

Mounting pitches





فرست اوتوماشن

# Push Buttons

Series CZ0202



Illustration	Order No.
 <p>CZ0202</p>	<b>CZ0202-903-LR</b>
	<b>CZ0202-903-LG</b>
	<b>CZ0202-903-LY</b>
	<b>CZ0202-903-LB</b>
	<b>CZ0202-903-LW</b>
	<b>CZ0202-901-LR</b>
	<b>CZ0202-901-LG</b>
	<b>CZ0202-901-LY</b>
	<b>CZ0202-901-LB</b>
	<b>CZ0202-901-LW</b>
	<b>CZ0202-902-LR</b>
	<b>CZ0202-902-LG</b>
	<b>CZ0202-902-LY</b>
	<b>CZ0202-902-LB</b>
<b>CZ0202-902-LW</b>	







فرست اوتوماشن

# Push Buttons

Series CZ0202



## Accessories

	<p>For label of <math>\Phi 39</math>mm, laser markings in 1-2 lines CZ4000-4031/1</p>
	<p>For label of <math>\Phi 39</math>mm, laser markings in 2-3 lines CZ4000-4031/6</p>
	<p>For label of <math>\Phi 39</math>mm, laser markings in 1-2 lines CZ4000-4031/4</p>
	<p>Yellow labels for E-stop pushbuttons are used for operation heads of <math>\Phi 40</math>mm CZ4000-4032/0</p>







فرست اتوماشن

# Push Buttons

Series CZ0202



## Accessories

	<p>Yellow labels for E-stop pushbuttons are used for operation heads of <math>\Phi 40\text{mm}/\Phi 55\text{mm}</math> CZ4000-4003/10</p>
	<p>Spanners are used to tighten plastic nuts M30x1.5 4000-4006</p>
	<p>Brass padlock B1730</p>
	<p>Spare key is general-purpose Y001-G01</p>
	<p>Flexible cable  <math>2 \times 0.75\text{mm}^2</math>  <math>3 \times 0.75\text{mm}^2</math>  <math>4 \times 0.75\text{mm}^2</math>  <math>2 \times 1.5\text{mm}^2</math>  <math>4 \times 1.5\text{mm}^2</math></p> <p>Flexible cable, length 3m  RVV <math>2 \times 0.75/3</math>  RVV <math>3 \times 0.75/3</math>  RVV <math>4 \times 0.75/3</math>  RVV <math>2 \times 1.5/3</math>  RVV <math>4 \times 1.5/3</math></p>